

EcoShape – The Next Dimension in Tubular Framing Systems



EcoShape – all your requirements met in a flash

In production lines, every movement counts towards maximizing efficiency and cost-effectiveness. Tools and components need to be available whenever and wherever they are needed. The combination of lean production and ergonomics results in an unbeatable strategy with short production throughputs and low costs. EcoShape fulfills all these requirements and more, with ultimate flexibility and enhanced quality. Accessories from the Manual Production Systems (MPS) range can also be used with all EcoShape workstations and flow rack systems.



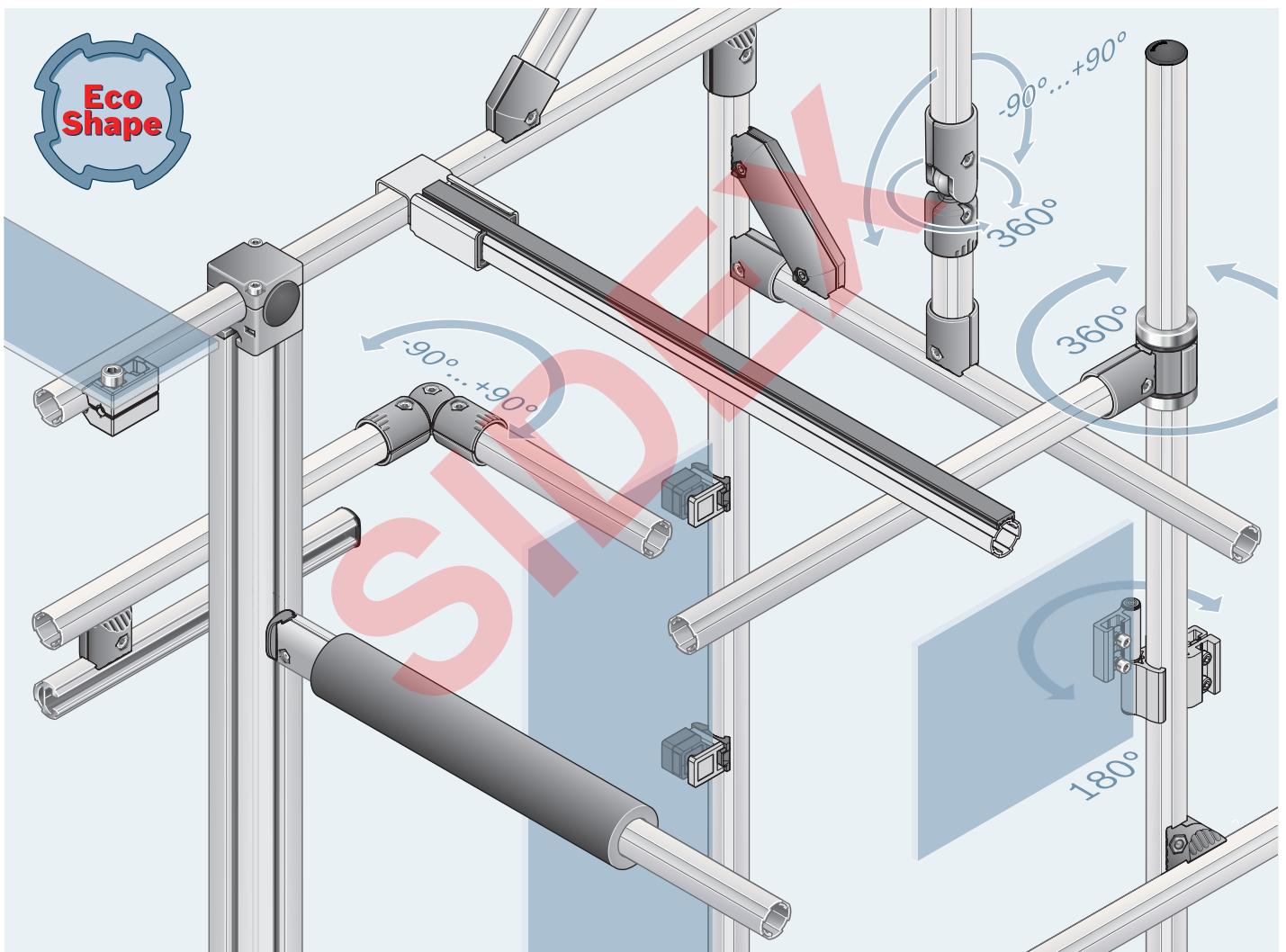

Flexibility at its best: with EcoShape's smart design, you can implement all of your ideas with just a few components – from material shuttles to flow racks and transport racks, up to workstations and entire assembly islands. Planning with software support and the subsequent assembly with intelligent connector technology is a breeze.

EcoShape – versatile, simple, efficient.

- | | |
|----|--------------------------|
| 4 | Easy ³ |
| 6 | Workstations |
| 8 | Material shuttles |
| 10 | Flow and transport racks |
| 12 | Assembly islands |
| 14 | Design solutions |
| 16 | Simple construction |

Easy³ – versatile, simple, efficient



Unmatched versatility

EcoShape is unmatched in its versatility: It makes an almost unlimited number of designs possible with just a few components. The only tubular framing system of its kind, it is T-slot enabled and fully compatible with the profiles in Rexroth's Modular Aluminum Framing System and Manual Production Systems. So you have even more freedom to design professional, custom workstations, material shuttles, and flow racks to meet your needs, as well as many other applications.

- ▶ Unique flexibility and versatility for the widest variety of combinations
- ▶ Create versatile and uniform applications
- ▶ Achieve high stability with aluminum tubes and ingeniously engineered connector technology
- ▶ Professionally extend and optimize existing production lines

Strikingly simple

It's child's play to create new solutions or expand existing ones with EcoShape: Intelligent connector technology easily accommodates small tolerance differences to make it easier to cut the round tubes directly on site. As a result, you can improve your production continuously with minimal additional effort, adapting quickly to changing requirements in accordance with the kaizen principle.

- ▶ Create the perfect configuration in no time at all with MTpro planning software
- ▶ Implement practical applications almost anywhere in record time with only 31 standard components
- ▶ Cut, assemble, and handle with ease
- ▶ Quickly create reliable and stable connections
- ▶ Set up new applications simply, or optimize and expand existing ones with surprisingly little effort

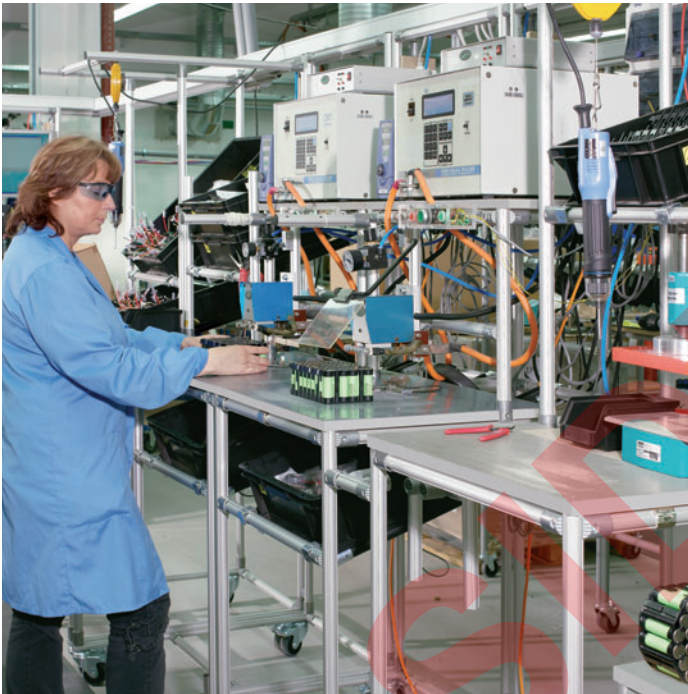

Sustainability and functionality from the very start

EcoShape is cost-effective yet still an investment that pays off for years. The tubes and connectors will neither rust or wear, making them ideal for long-term use and reuse. Once installed, they can be quickly supplemented or converted to meet new requirements, based on the kaizen principle of continuous improvement. Or you can simply repurpose individual components. The durable, anodized aluminum parts will effortlessly meet your demands. Once the products have reached the end of their lifecycle, EcoShape offers impressive sustainability: all components can be easily recycled and fed back into the production cycle.

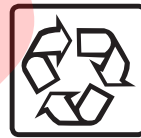

Top efficiency

It's nearly impossible to achieve greater efficiency: EcoShape combines unbeatable flexibility and versatility with simple handling. The system has been designed in line with the poka yoke philosophy, making it impossible for users to go wrong when assembling the system.

- ▶ Configure and assemble directly on-site (gemba) – saves time and avoids errors (poka yoke)
- ▶ Achieve higher stability thanks to optimized profile and connector geometries – with an approximate reduction in weight of over 30% compared to similar steel tube systems

Future-forward design

All components in the EcoShape system are fully conductive and thus suitable for use in areas prone to electrostatic discharge (ESD). EcoShape has proven itself as an ideal solution for production equipment in the electronics industry. All connection elements are designed so that the anodic coating on the aluminum profiles is broken to ensure ESD conductivity throughout the system without the need for risky extra cabling.



Workstations – scalable solutions from simple to complex

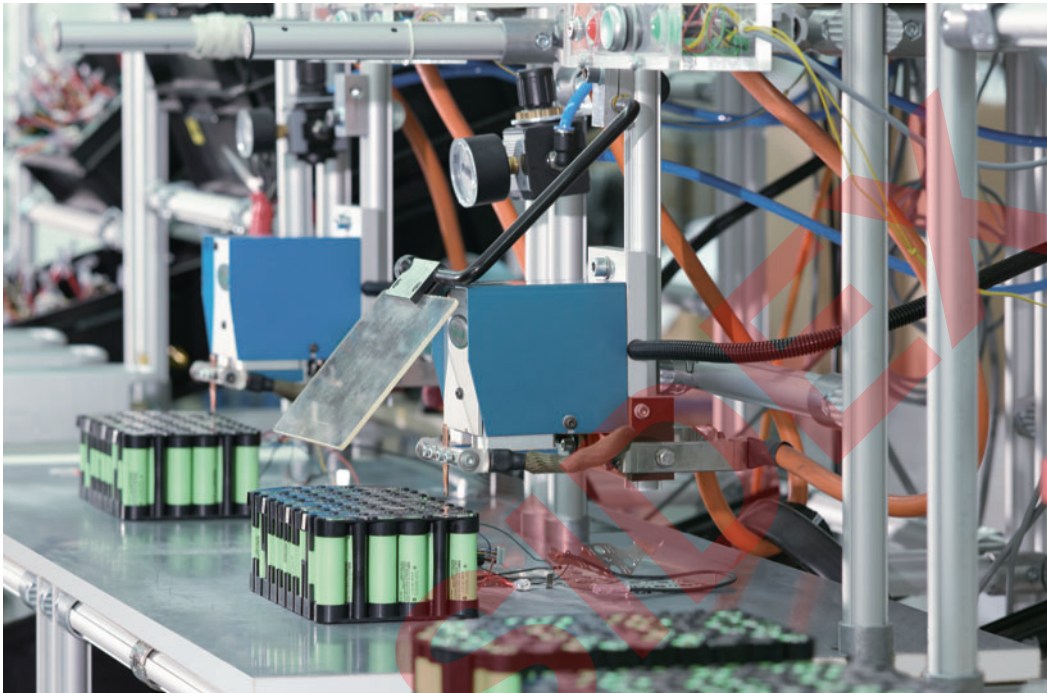

- ▲ Improved ergonomics thanks to angled grab containers
- ◀ Quick adaptation of workstations to new requirements
- ▼ ESD assembly line

Individual workstation or assembly line? Anything is possible.

With EcoShape you can design your workstations to meet your exact needs – and provide maximum comfort, ergonomics, and support for routine processes to your employees.

Even if your production conditions or volumes change, you're on the safe side with EcoShape. With this flexible system, your workstations can be quickly converted to meet new requirements. EcoShape meets high demands for ergonomics and is particularly suited for applications in the electronics industry with its consistent ESD conductivity.





- ▲ **Space-saving, functional organization of packaging material: no problem with flexible EcoShape elements**
- ◀ **Ideal components, even for the most complex tasks**

MTpro: Just a few clicks away from the perfect result!

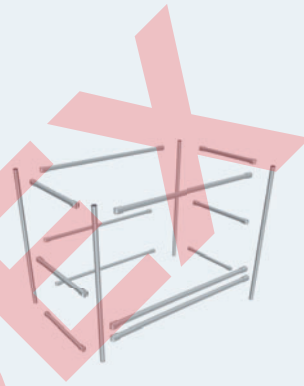

Ergonomic workstations in just a few steps: easy planning and setup with MTpro.

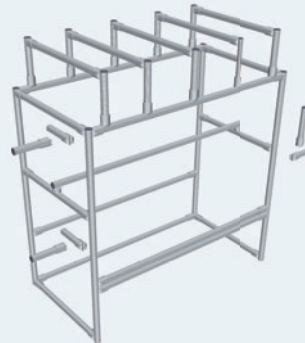

EcoShape frame library available for download



www.boschrexroth.com/ecoshape-library

Material shuttles – flexible design for flexible use



Ergonomics and mobility play a key role in your industrial production: material shuttles made from EcoShape components provide an ideal combination of these two aspects.

Supply shuttles bring all required components to the assembly site; small parts are made available in ergonomically positioned grab containers. Whether angled surfaces for ergonomic extraction from boxes, transport shuttles for smooth order picking, or logistics solutions for pre-assembly: material shuttles made from EcoShape tubular frames can be optimally used in every application area. They can be constructed and set up quickly and cost-effectively, and offer excellent flexibility in handling.

- ◀ **Angled EcoShape tubes enable the ergonomic storage of boxes and small loads**
- ▲ **Picking carts provide optimum support for your employees on the production line**
- ▶ **Logistics shuttles assist with the transport of components and workpieces near the pre-assembly islands**





▲ Supply shuttles save time and reduce costs

▶ Ergonomic supply of small parts

▼ Picking carts for customer-specific production

▼ Stable, easy-to-assemble chassis



Configuration in a flash thanks to MTpro

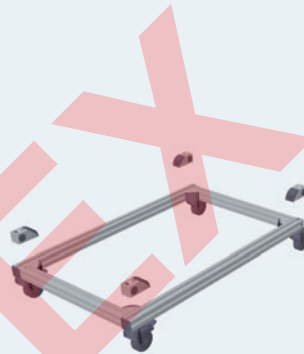

Fast planning, simple installation with optimum stability: EcoShape in combination with 45 mm profiles.



EcoShape frame library available for download



www.boschrexroth.com/ecoshape-library

Flow racks and transport racks – versatile solutions with a single system



Jump start your production

An optimum material flow is one of the important prerequisites for efficient production. With EcoShape tubular frames, you can create flow racks and transport racks based on your exact needs. Rest assured that required components and tools are always available, on time, and exactly where they are needed on the assembly line.

EcoShape tubular frames combine stability with functional, attractive design and safe, torsion-resistant connections. Though robust, EcoShape profiles are also especially light: made of anodized aluminum, they offer a weight reduction of up to 34% compared to other systems – an invaluable benefit, both for assembly and in everyday mobile applications.

▲ Batteries must be stored in ESD-capable flow racks – the perfect job for EcoShape.

▼ Your ideal supermarket: with incredibly flexible parts storage



Simple solutions for complicated tasks with MTpro

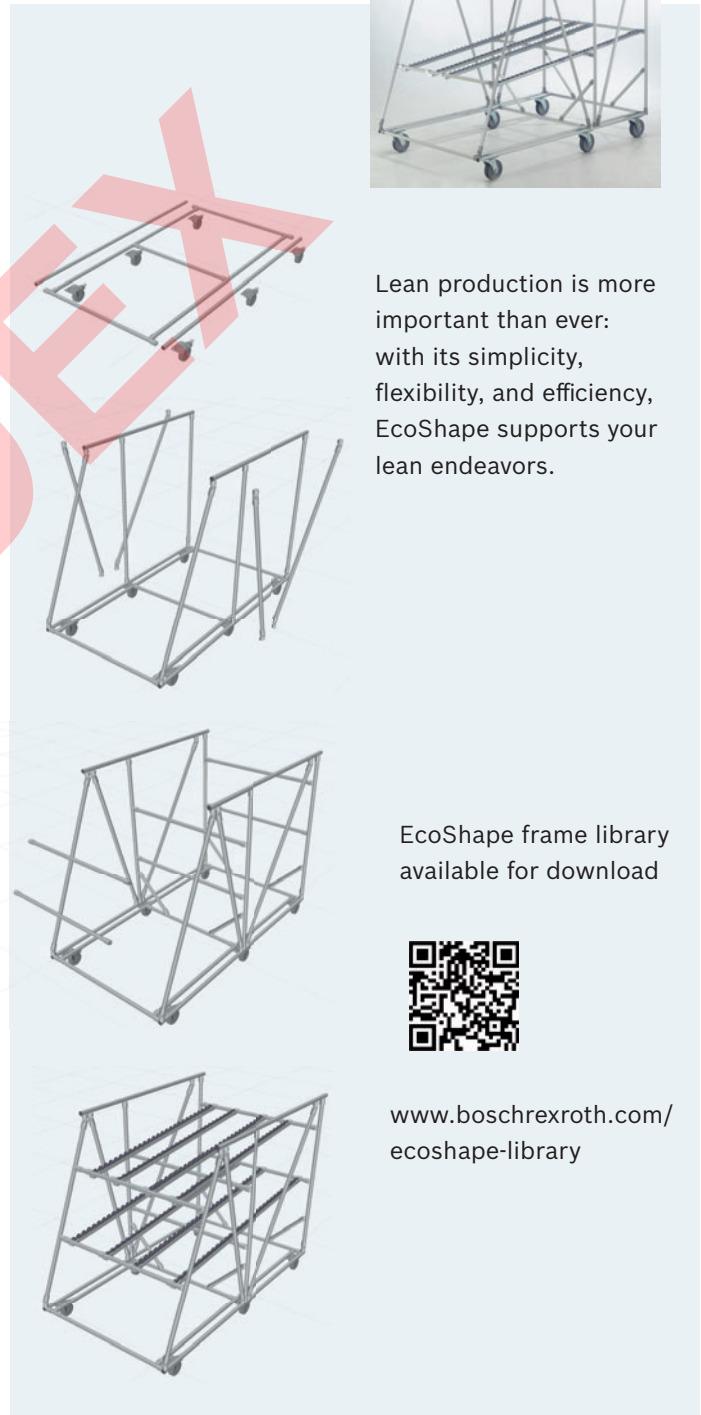

Lean production is more important than ever: with its simplicity, flexibility, and efficiency, EcoShape supports your lean endeavors.

EcoShape frame library available for download



www.boschrexroth.com/ecoshape-library

- ▲ Despite its lightweight design, EcoShape is extremely robust and also well-suited for flow rack construction
- ▶ First in, first out: demand-based supply of housing elements in an EcoShape flow rack



Assembly islands – ergonomic and functional



- ▲ Versatile design options for all applications
- ◀ Top flexibility with mobile small parts storage
- ▼ Easy, optimized material supply in an assembly island

The right answer for any production situation

EcoShape components for assembly islands are not only fast and efficient to install. EcoShape also helps your assembly line teams to work faster and more efficiently: every required component is within easy reach, for example in angled ergonomic containers. Mobile elements provide the necessary flexibility all along the production line.

The easy, fast assembly of EcoShape also enables rapid adjustments to new conditions – and the continuous improvement of your assembly islands and processes according to the kaizen principle. With versatile configuration options, you can meet all the requirements of manual handling.





MTpro: Just a few clicks away from the perfect result!



Even for complex requirements, the basic principle for EcoShape is versatility, simplicity, and efficiency – from planning to implementation.



▲ **Stability is essential for the production of large, heavy components – simply combine EcoShape with 45 mm profiles while maintaining the flexibility of this innovative system**

▼ **Flow racks built from EcoShape components for the supply of materials on assembly lines**

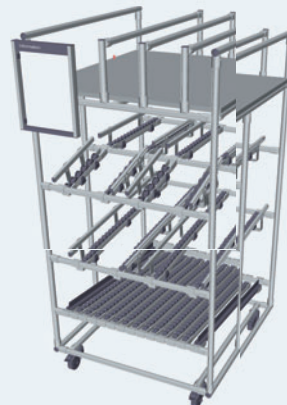

EcoShape frame library available for download



www.boschrexroth.com/ecoshape-library

Design solutions – fresh ideas from a single system



Ensci les ateliers



Ensci les ateliers

Aesthetics meet function

EcoShape is more than a tubular frame system for the industrial sector. As a design solution, the innovative system also offers creative challenges. Whether in studios, offices, public buildings, for booth construction or retail installations, EcoShape creates exciting accents with its unconventional yet practical solutions.

- ▲ **New age communication: an eye-catching meeting area**
- ▲ **Ideal for a variety of applications: practical aid for photo studios**
- ▼ **EcoShape for your breaks: modern bench arrangement**

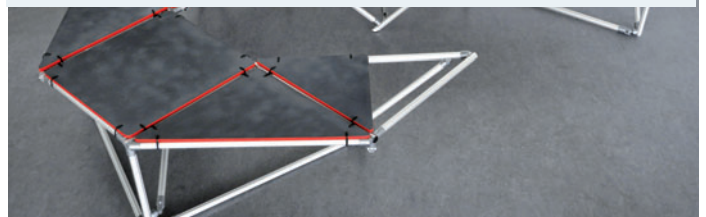



▲ Attractive trade fair booths: quick setup and dismantling with EcoShape

▶ Creative environment: table group at a college of art



▼ Quick information: brochure holder combined with various materials



◀ Perfectly organized: cleaning stand based on the 5S principle
▶ Designer desk lamps: just another option with EcoShape
▼ For taking it easy: the hammock holder



Vanille Design



Vanille Design

Exceptional requirements – the right solution for every load case



Mastering difficult tasks with ease

EcoShape components made of anodized aluminum are both remarkably light and delicate, yet incredibly stable. However, a few rules must be followed when assembling constructions: for spans longer than 1,500 mm, for example, additional cross members should be installed to prevent bending of the tubular frames. Torsion can be prevented through properly placed reinforcements. For larger loads, you can easily get your construction in shape with double tubular frames.

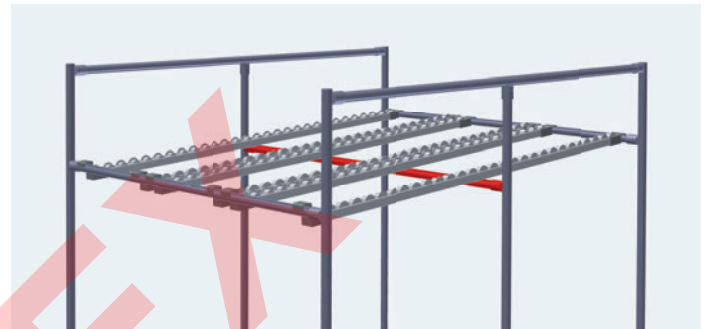

Supporting heavy loads – with enormous strength

Span widths and roller sections over 1500 mm for transporting heavy loads are no problem for EcoShape and its flexible system components. Additional cross members at the center or at planned intervals ensure increased stability and a high loading capacity – perfectly adapted to your requirements.

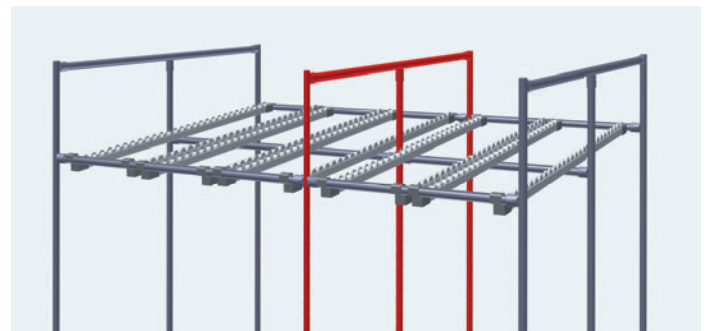

Bridging long widths – no problem

Supply racks can be easily constructed with widths up to 1500 mm with EcoShape. For heavier weights, the frame is stabilized with additional side elements.

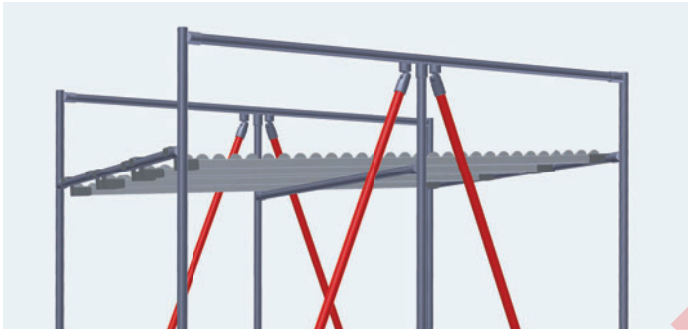

Avoiding torsion – with absolute reliability

To prevent warping of your EcoShape construction, even with heavy loads, it can simply be equipped with stabilizing longitudinal reinforcements. EcoShape's flexibility is demonstrated by its large variety of designs. Lightweight transport tasks can be accomplished with simple constructions.



Designed for high requirements

Fully convincing: with just a few supporting elements, you can give your EcoShape construction enough stability and strength to meet all your demands, also in terms of loading capacity.

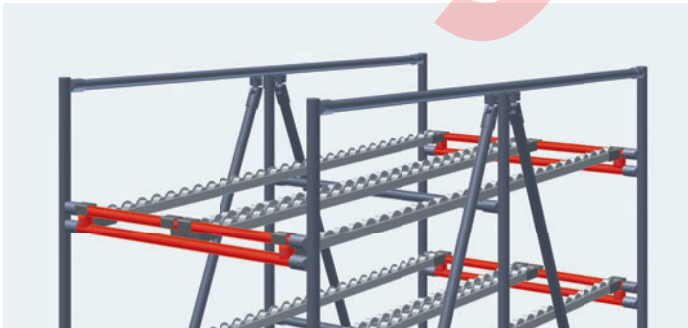

Withstanding heavy loads – effortlessly

There is virtually no limit when it comes to increasing the loading capacity of EcoShape constructions. For especially sturdy cross ties, round tubes are simply doubled using parallel connectors.

MTpro planning software – fast, reliable planning

First plan, then order – it's that easy with MTpro planning software

MTpro is the high-performance, yet easy-to-use software from Rexroth that supports you in planning your assembly systems, without any prior knowledge of CAD. The user-friendly program guides you through a series of steps, from component selection to configuration and ordering of required parts.

MTpro features:

- ▶ Layout Designer for fast planning of complete frames and conveyor systems
- ▶ Simple planning via drag & drop
- ▶ No knowledge of CAD required
- ▶ Graphical user interface and multilingual content in 7 different languages (de, en, fr, es, it, jp, zh)
- ▶ ManModel function for ergonomic workstation planning
- ▶ User library to reuse your own modules
- ▶ Export of 3D models in all common CAD formats
- ▶ Automatic parts list generation with all accessories and small parts, including calculation of order lists
- ▶ Product information for Rexroth product lines
- ▶ MGE (Basic Mechanical Elements), MPS (Manual Production Systems), MIT (Material and Information Flow Technology)

With its “ManModels”, MTpro planning software can optimally adapt constructions for individual workers – with the perfect reach zone, the right distance to equipment, and the ideal angle of vision. The reach zone should be easily accessible from the working position and assist workers in avoiding unhealthy postures. It is divided into the working area directly within reach of the seated employee, the large reach zone, and the extended one-hand zone at the periphery.

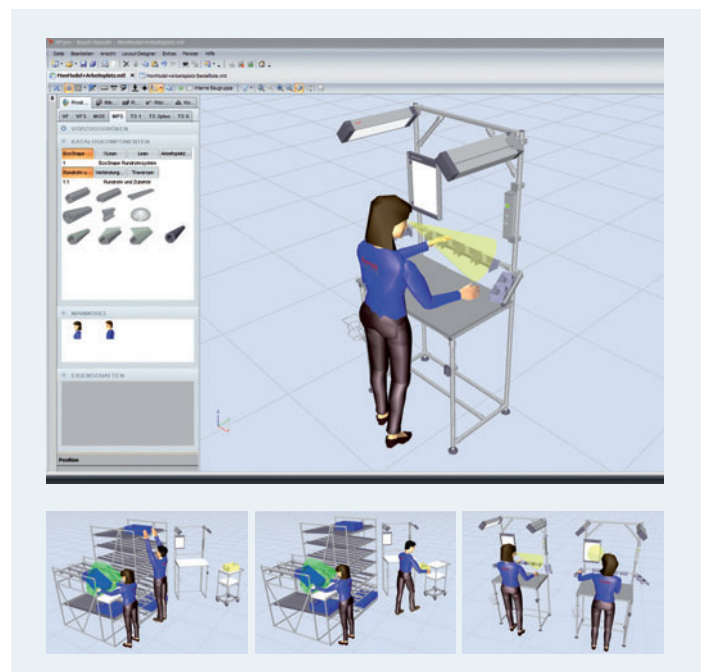
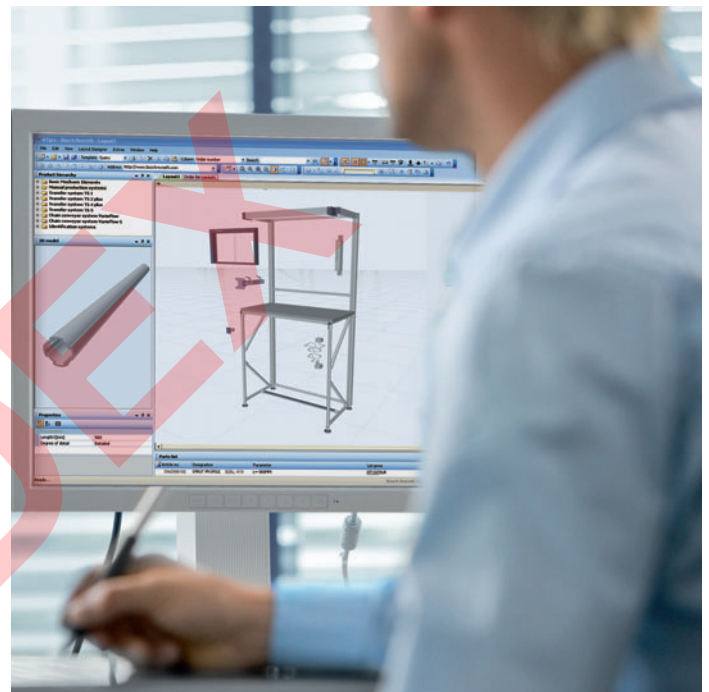

31 components – endless possibilities

Consistent simplicity and efficiency are key features of the EcoShape system: just a few components are all you need to create everything from simple transport shuttles to entire assembly lines.

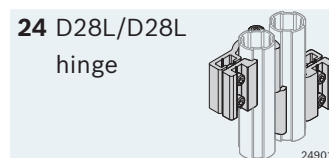
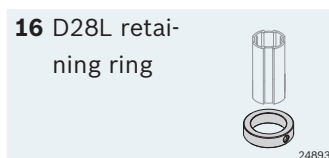
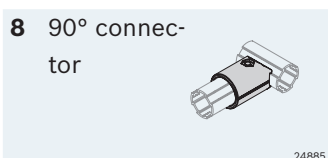
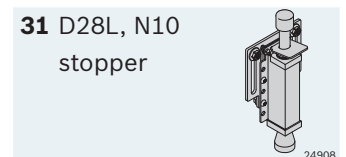
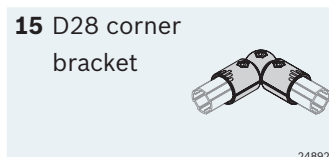
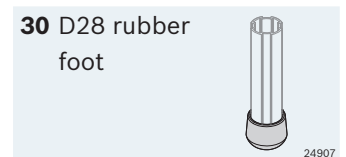
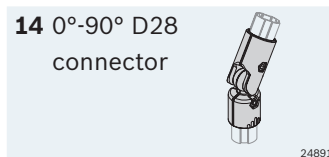
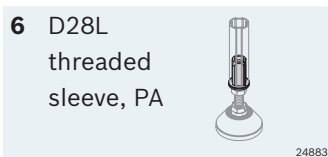
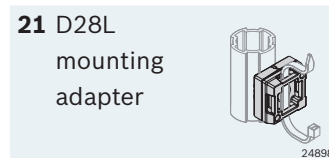
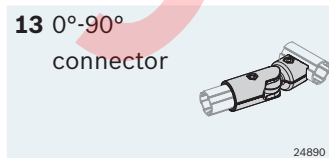
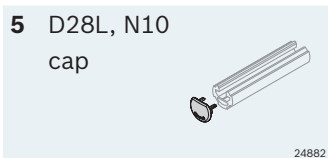
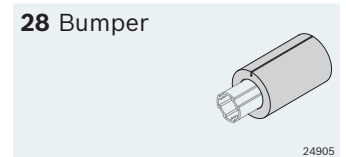
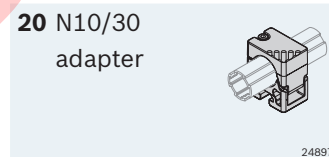
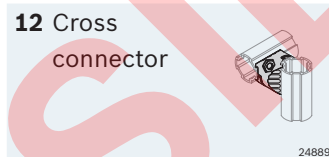
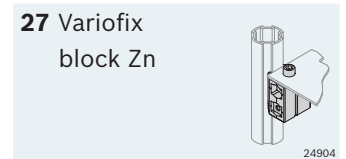
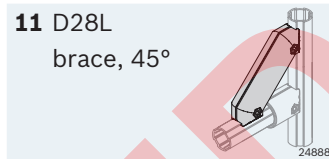
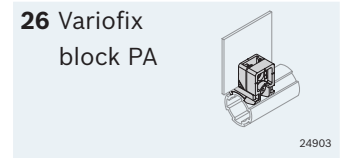
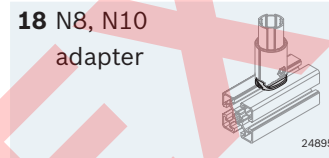
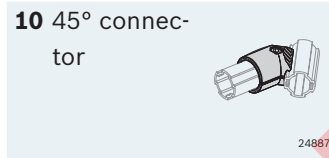
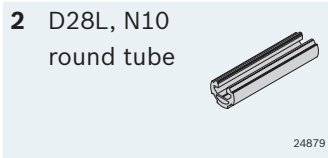
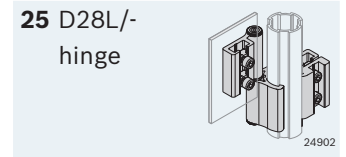
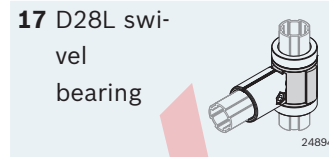
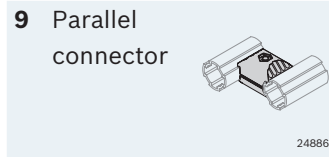
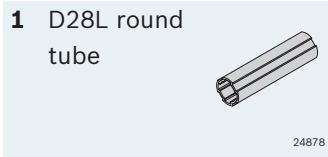
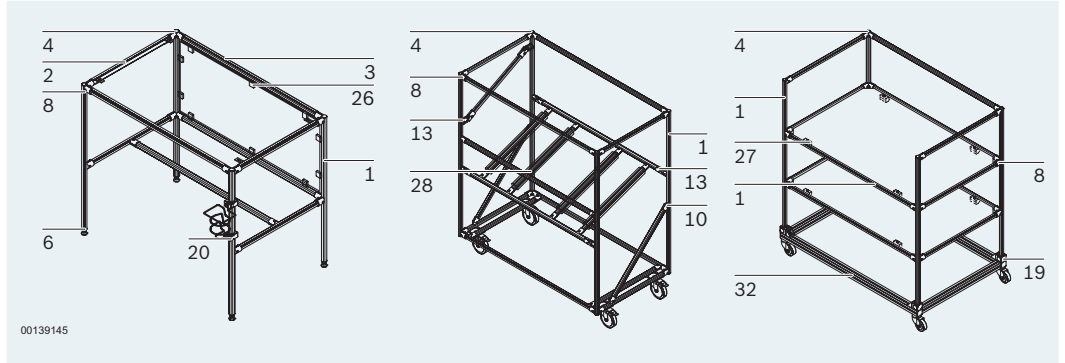

Bosch Rexroth AG

Postfach 30 02 07
70442 Stuttgart, Germany
www.boschrexroth.com

You can find local contact information at:

www.boschrexroth.com/contact

SIDEX

3 842 542 277 (2014-04)
© Bosch Rexroth AG 2014
Subject to changes!

The data specified above only serve to describe the product. No statements concerning a certain condition or suitability for a certain application can be derived from our information. The information given does not release the user from the obligation of own judgment and verification. It must be remembered that our products are subject to a natural process of wear and aging.